

TAMPEREEN KAUPUNKI
Kaupunkimittaus

Asemakaava-alueen osoitteenvahvistus n:o [4414](#)
11.7.2018, Osoitevastaava

Jarvensivu, 130

Kiint.tunnus	Osoite	Vanha kiinteistö tai rakennus mihin kohdistuu	Os.vahv. aiheuttaja
130-939-1	Turjankatu 1d	592-1-27-002 (muuntamo)	Tj 11.7.2018

837-592-0001-0031

Järvensivun kylä

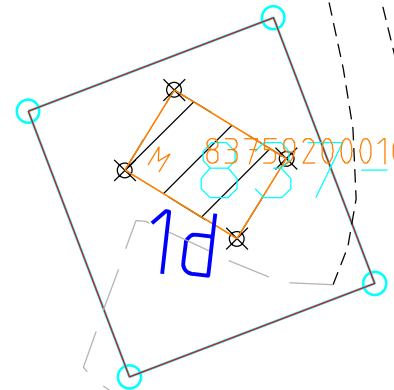

837-130-0939-0001

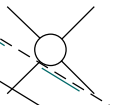
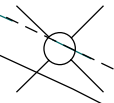
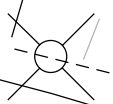
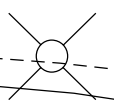
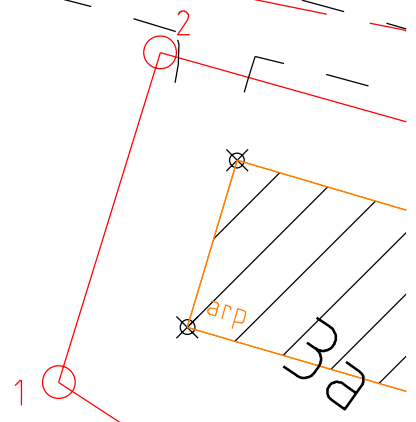

Turjankatu

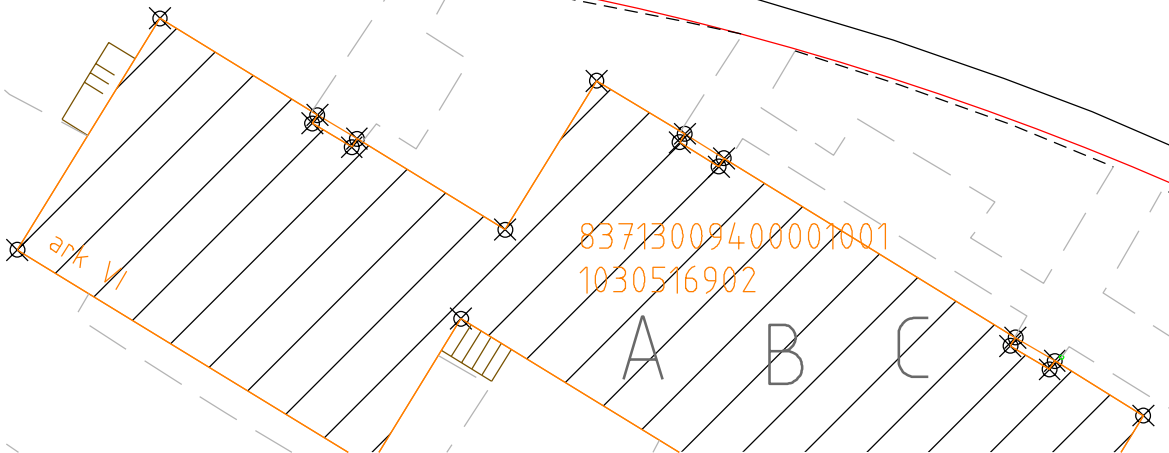

2

8

8